

0 607 561 102; 106

Issue } 05-01-17
Stand } **Fig./Abb. 1**

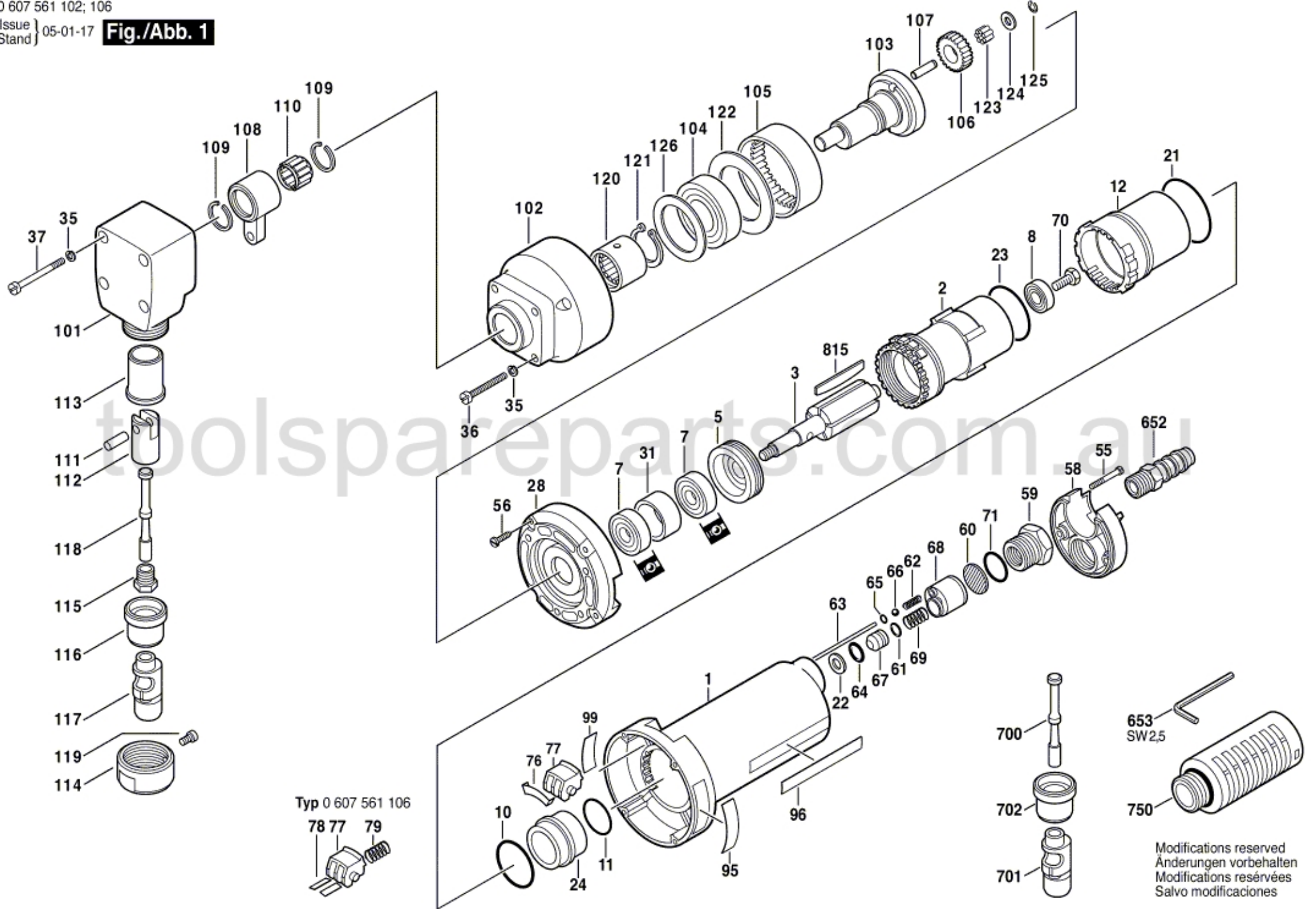

Typ 0 607 561 106

Modifications reserved
Änderungen vorbehalten
Modifications réservées
Salvo modificaciones